

M

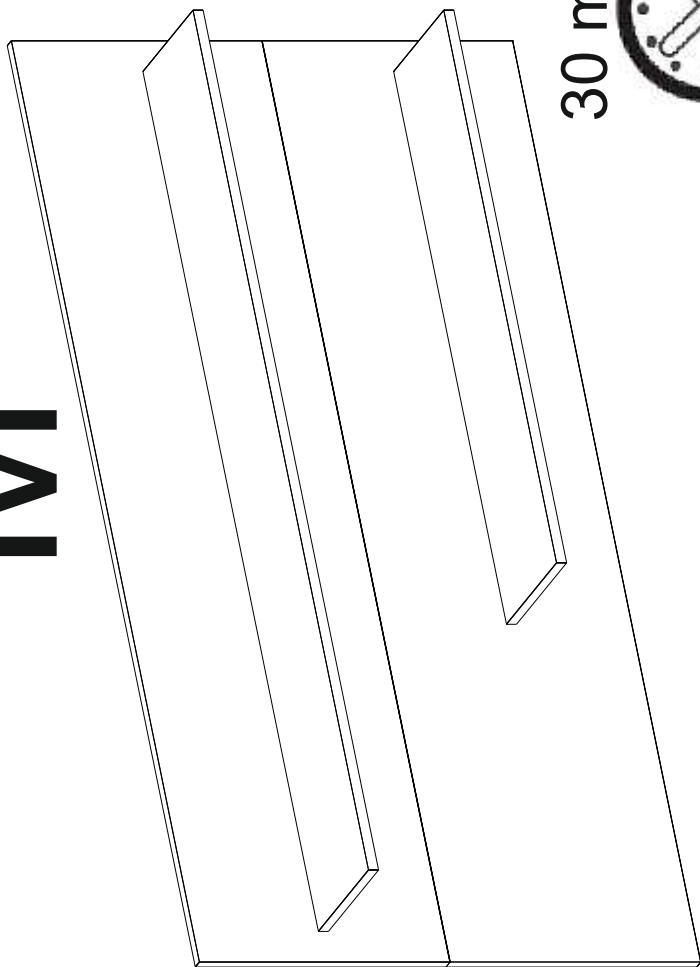

30 min

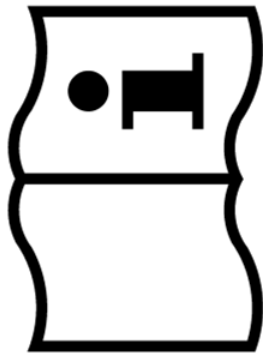

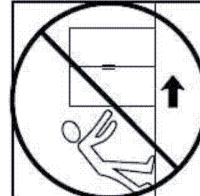
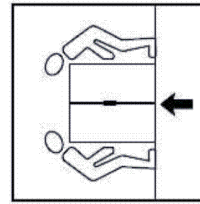
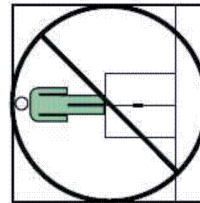
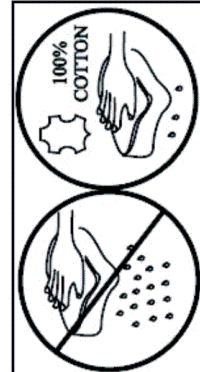
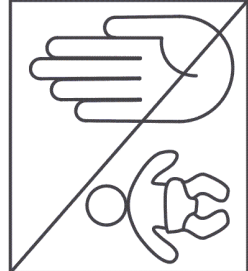
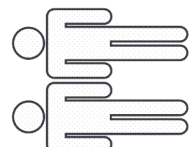
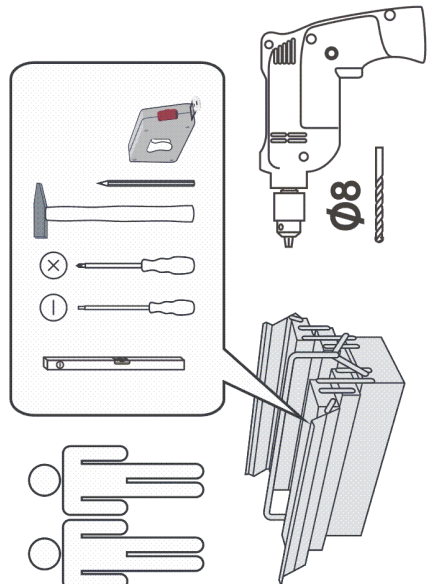
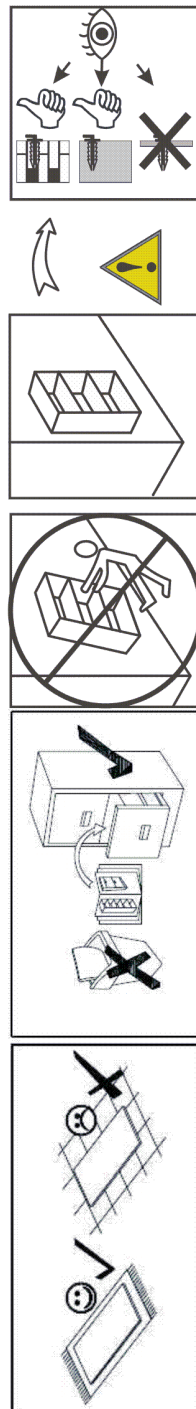
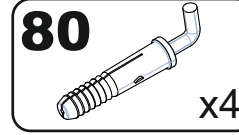
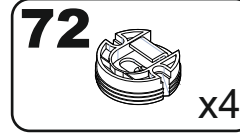
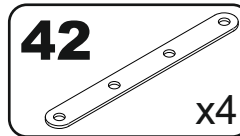
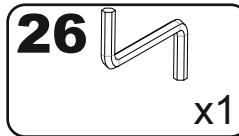
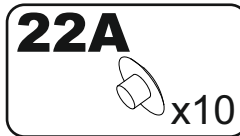
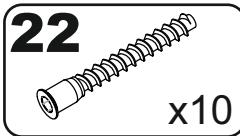
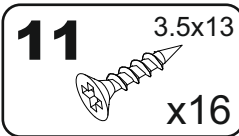
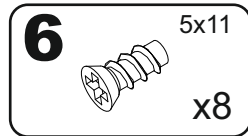
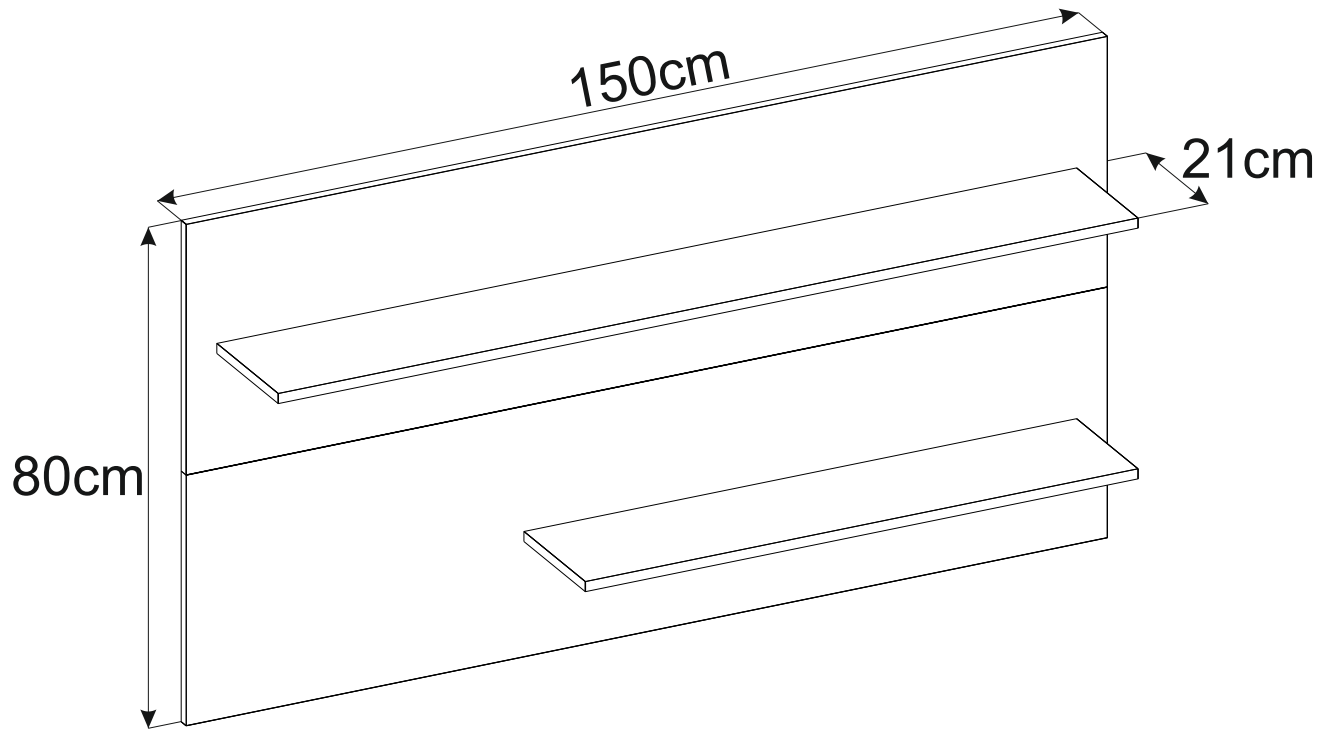
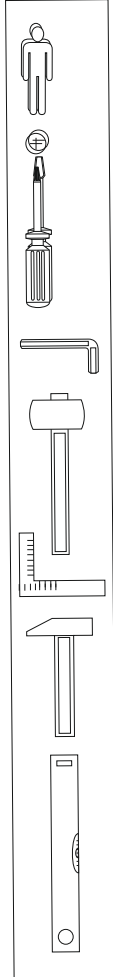

M

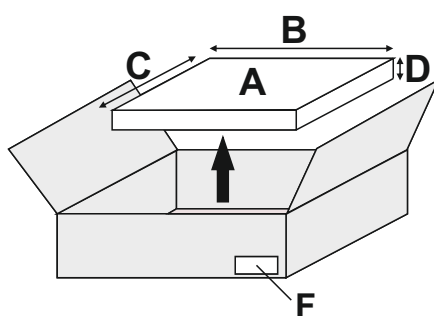
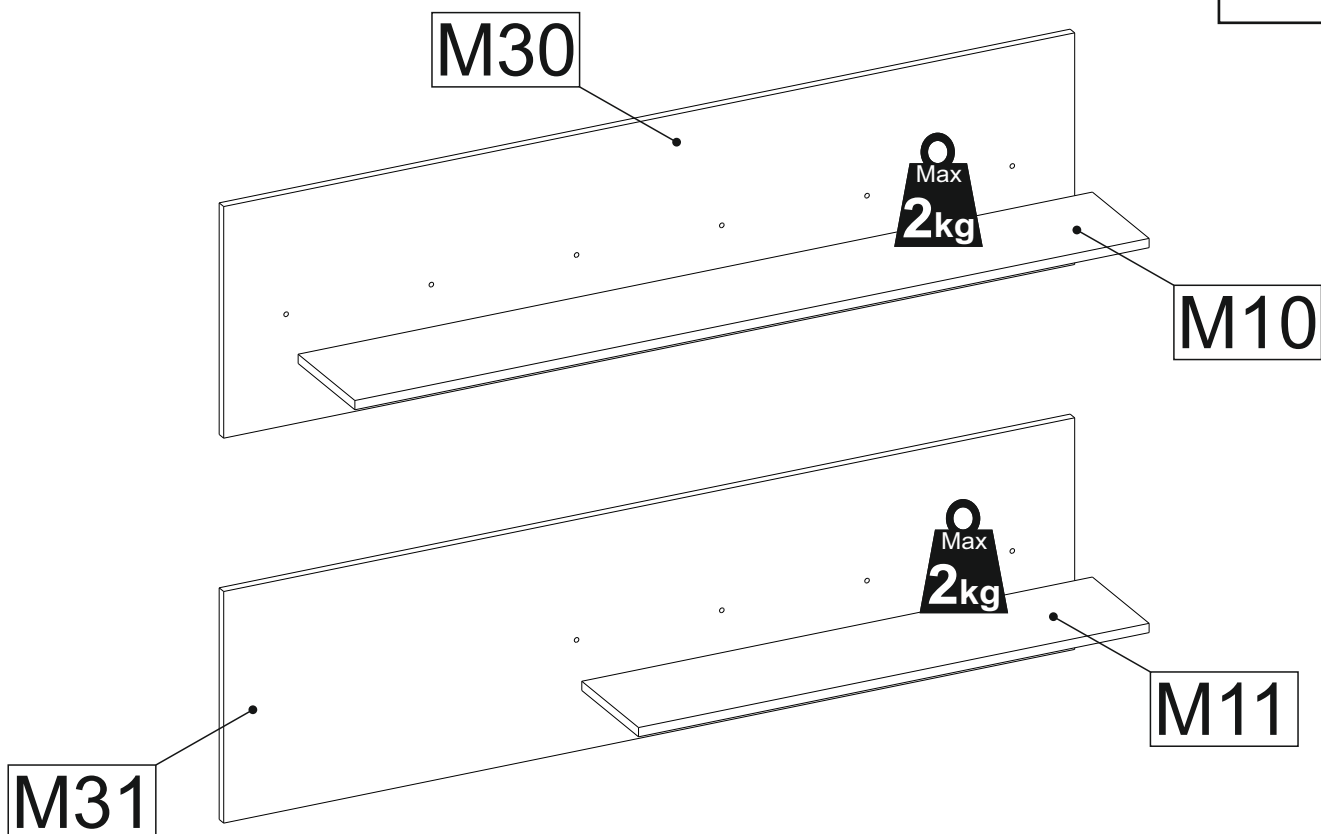
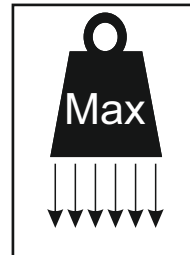

A	B_(mm)	C_(mm)	D_(mm)	E	F
M10	1400	200	16	1	1 1
M11	900	200	16	1	1 1
M30	1500	400	16	1	1 1
M31	1500	400	16	1	1 1

1

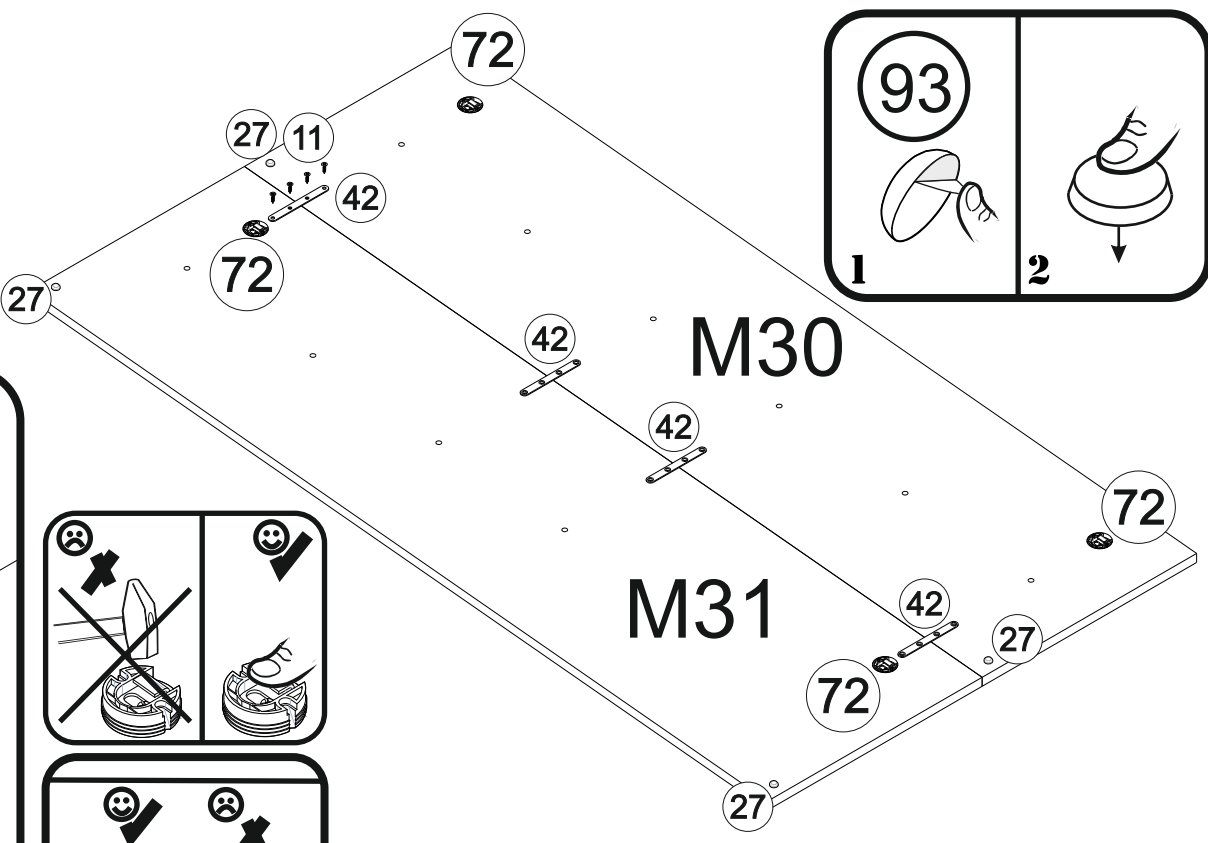
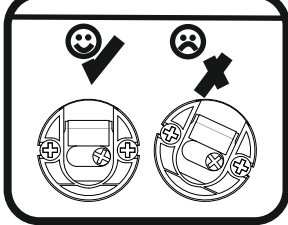
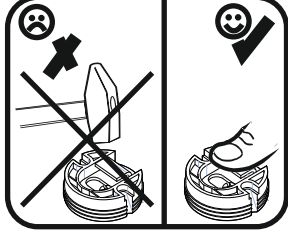
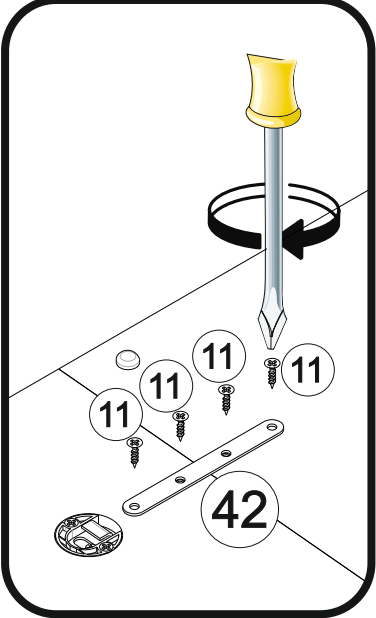
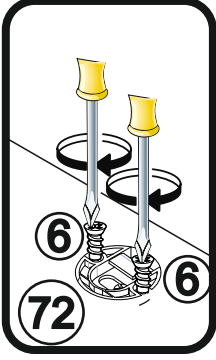
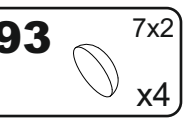
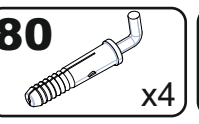
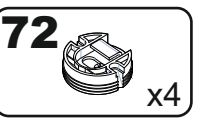
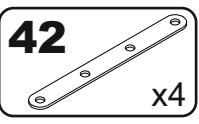
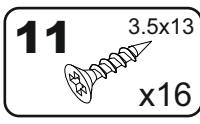
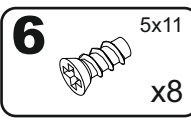

2

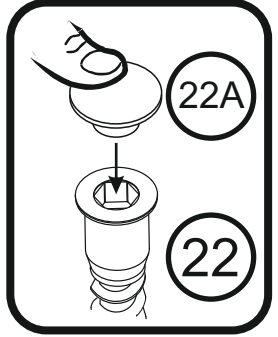
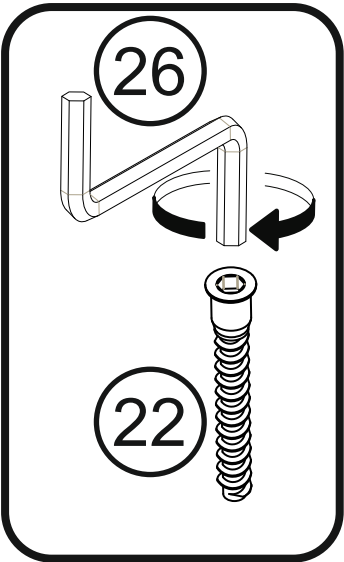
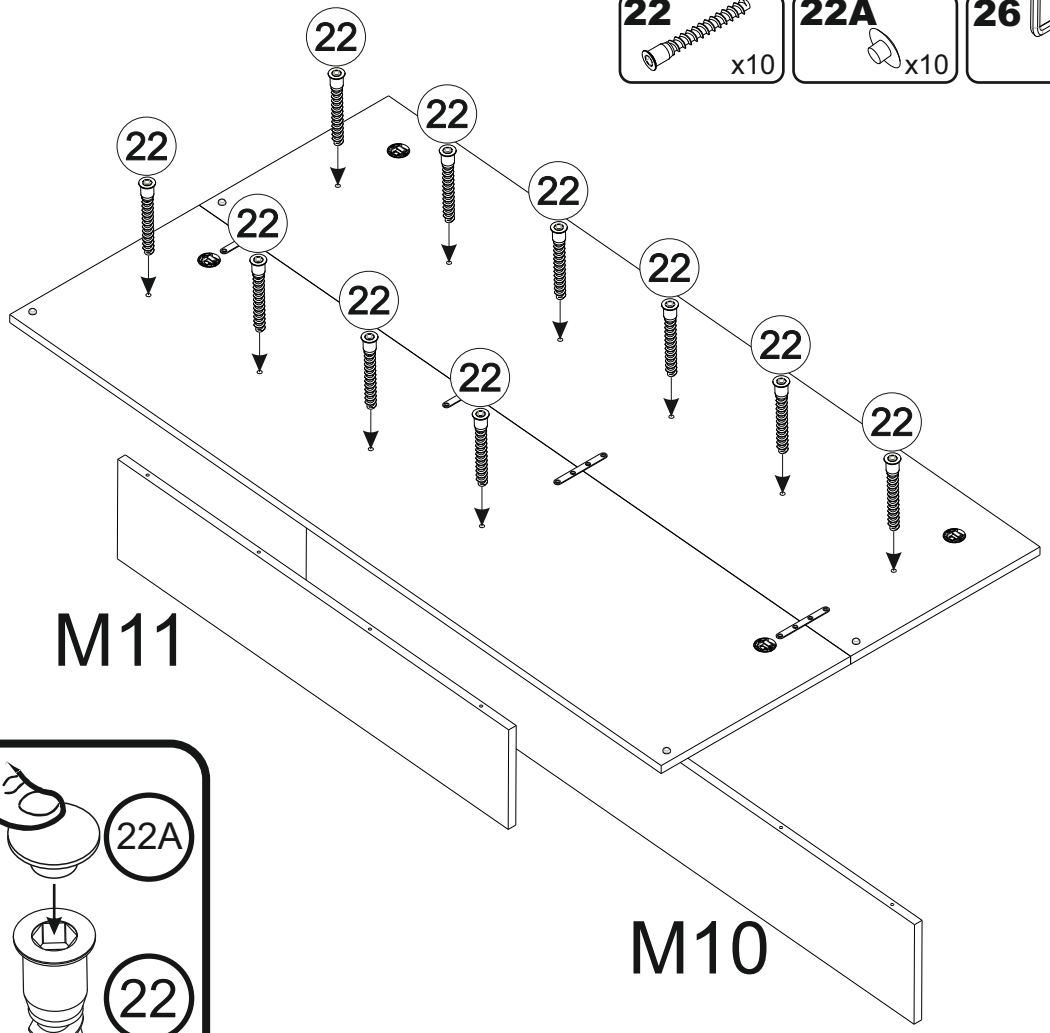
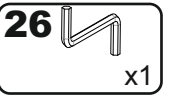
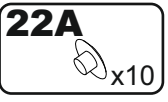
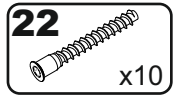

3

